

RF power transistor the LdmoST plastic family

Features

- Excellent thermal stability
- Common source configuration
- Broadband performances $P_{OUT} = 1\text{ W}$ with 15 dB gain @ 870 MHz
- Plastic package
- ESD protection
- Supplied in tape and reel
- In compliance with the 2002/95/EC european directive

Description

The PD84001 is a common source N-channel, enhancement-mode lateral field-effect RF power transistor. It is designed for high gain, broad band commercial and industrial applications. It operates at 7 V in common source mode at frequencies of up to 1 GHz.

PD84001's superior gain and efficiency makes it an ideal solution for portable radio and UHF RFID reader.

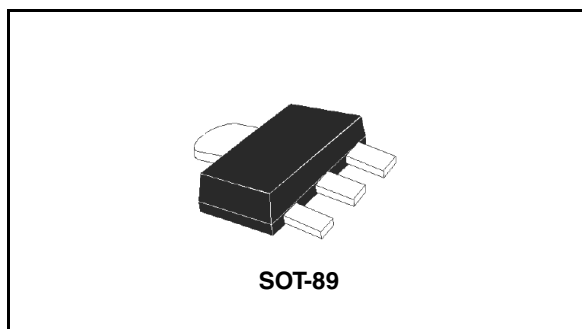

Figure 1. Pin connection

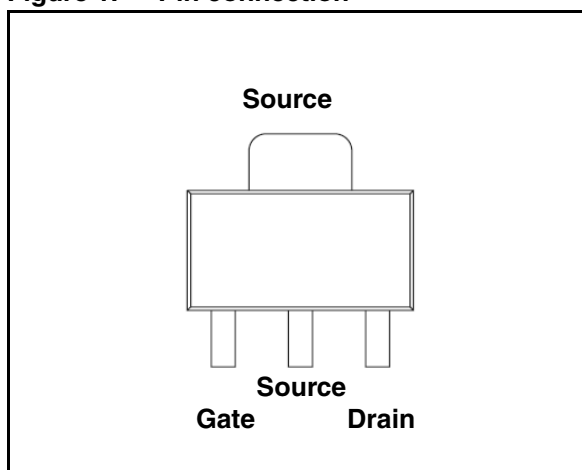

Table 1. Device summary

Order code	Marking	Package	Packaging
PD84001	8401	SOT-89	Tape and reel

Contents

1	Electrical data	3
1.1	Maximum ratings	3
1.2	Thermal data	3
2	Electrical characteristics	4
2.1	Static	4
2.2	Dynamic	4
2.3	ESD protection characteristics	4
2.4	Moisture sensitivity level	4
3	Impedance	5
4	Typical performance	6
5	Test circuit	11
6	Package mechanical data	12
6.1	Thermal pad and via design	14
6.2	Soldering profile	15
7	Revision history	17

1 Electrical data

1.1 Maximum ratings

Table 2. Absolute maximum ratings ($T_{CASE} = +25\text{ °C}$)

Symbol	Parameter	Value	Unit
$V_{(BR)DSS}$	Drain-source voltage	18	V
V_{GS}	Gate-source voltage	-0.5 to +15	V
I_D	Drain current	1.5	A
P_{DISS}	Power dissipation	6	W
T_J	Max. operating junction temperature	150	°C
T_{STG}	Storage temperature	-65 to +150	°C

1.2 Thermal data

Table 3. Thermal data

Symbol	Parameter	Value	Unit
R_{thJC}	Junction - case thermal resistance	21	°C/W

2 Electrical characteristics

2.1 Static

Table 4. Static ($T_{CASE} = +25\text{ }^{\circ}\text{C}$)

Symbol	Test conditions			Min.	Typ.	Max.	Unit
I_{DSS}	$V_{GS} = 0\text{ V}$	$V_{DS} = 28\text{ V}$				1	μA
I_{GSS}	$V_{GS} = 5\text{ V}$	$V_{DS} = 0\text{ V}$				1	μA
$V_{GS(Q)}$	$V_{DS} = 10\text{ V}$	$I_D = 250\text{ }\mu\text{A}$		2.0	3.0	5.0	V
$V_{DS(ON)}$	$V_{GS} = 10\text{ V}$	$I_D = 0.4\text{ A}$			0.6		V
C_{ISS}	$V_{GS} = 0\text{ V}$	$V_{DS} = 7\text{ V}$	$f = 1\text{ MHz}$		14.7		pF
C_{OSS}	$V_{GS} = 0\text{ V}$	$V_{DS} = 7\text{ V}$	$f = 1\text{ MHz}$		13.3		pF
C_{RSS}	$V_{GS} = 0\text{ V}$	$V_{DS} = 7\text{ V}$	$f = 1\text{ MHz}$		1.3		pF

2.2 Dynamic

Table 5. Dynamic

Symbol	Test conditions	Min.	Typ.	Max.	Unit
P_{OUT}	$V_{DD} = 7.5\text{ V}$, $I_{DQ} = 50\text{ mA}$, $P_{IN} = 17\text{ dBm}$, $f = 870\text{ MHz}$	30	31		dBm
G_{PS}	$V_{DD} = 7.5\text{ V}$, $I_{DQ} = 50\text{ mA}$, $P_{OUT} = 30\text{ dBm}$, $f = 870\text{ MHz}$	13	15		dB
h_D	$V_{DD} = 7.5\text{ V}$, $I_{DQ} = 50\text{ mA}$, $P_{IN} = 17\text{ dBm}$, $f = 870\text{ MHz}$	55	60		%
Load mismatch	$V_{DD} = 7.5\text{ V}$, $I_{DQ} = 50\text{ mA}$, $P_{OUT} = 1\text{ W}$, $f = 870\text{ MHz}$ All phase angles	20:1			VSWR

2.3 ESD protection characteristics

Table 6. ESD protection characteristics

Test conditions	Class
Human body model	2
Machine model	M3

2.4 Moisture sensitivity level

Table 7. Moisture sensitivity level

Test methodology	Rating
J-STD-020B	MSL 3

3 Impedance

Figure 2. Current conventions

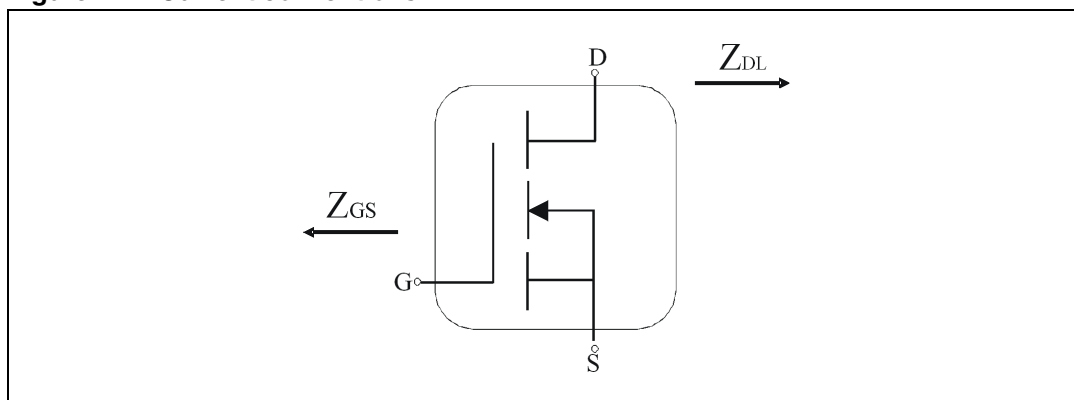

Table 8. Impedance data

Freq. (MHz)	$Z_{GS} (\Omega)$	$Z_{DL} (\Omega)$
920	$4.0 + j4.3$	$3.7 + j6.2$
900	$3.6 + j4.3$	$3.9 + j5.5$
880	$3.3 + j4.1$	$4.1 + j4.7$
860	$3.1 + j3.7$	$4.3 + j4.0$
840	$2.9 + j3.4$	$4.5 + j3.2$
820	$2.8 + j3.0$	$4.8 + j2.4$
800	$2.7 + j2.5$	$5.0 + j1.6$

4 Typical performance

Figure 3. V_{GS} vs I_D

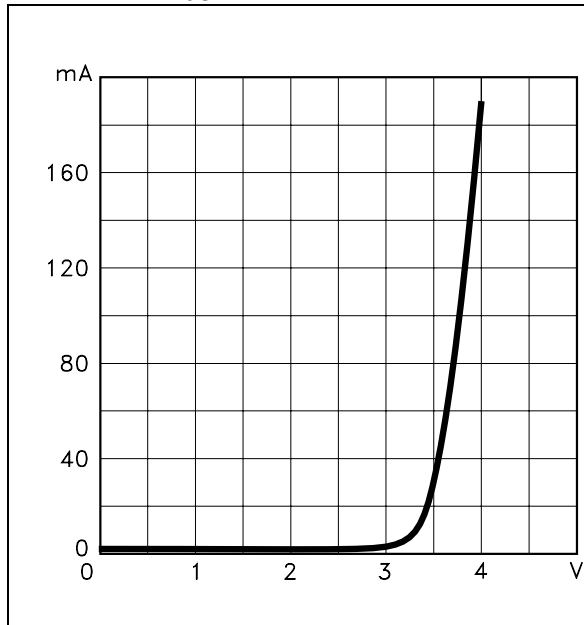

Figure 4. DC output characteristics

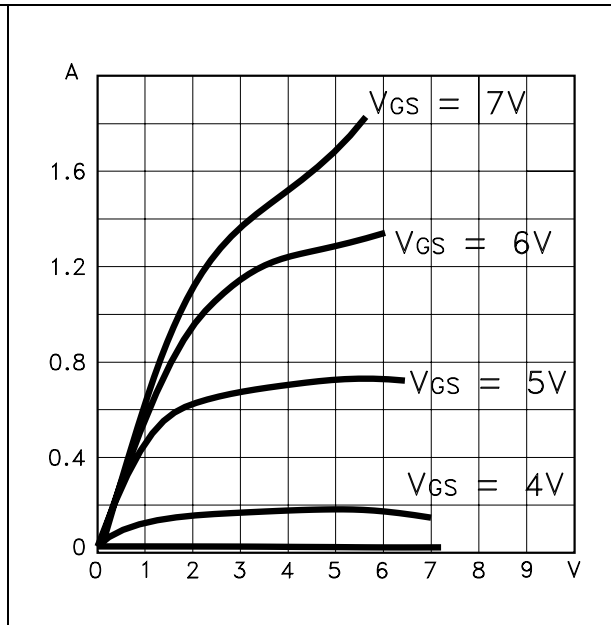

Figure 5. C_{RSS} vs V_{DS}

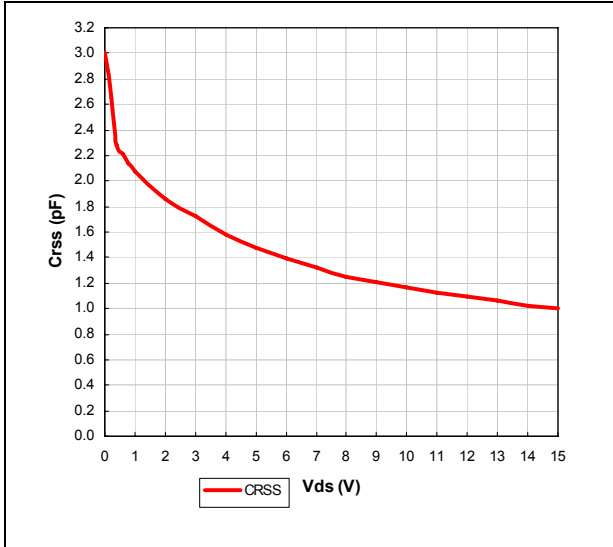

Figure 6. C_{ISS} vs V_{DS}

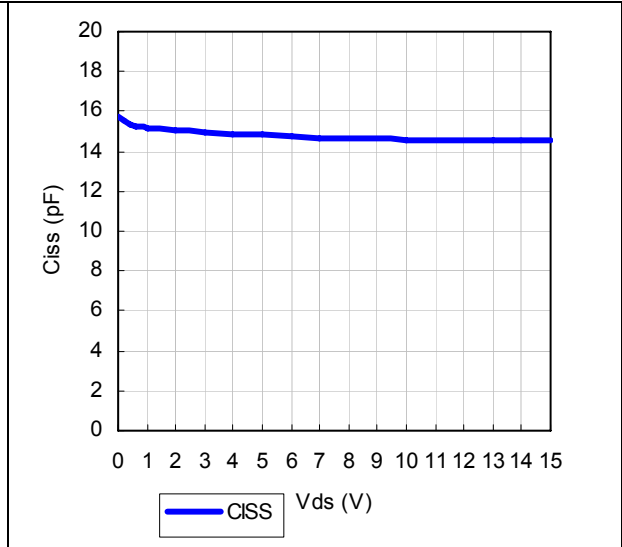

Figure 7. C_{OSS} vs V_{DS}

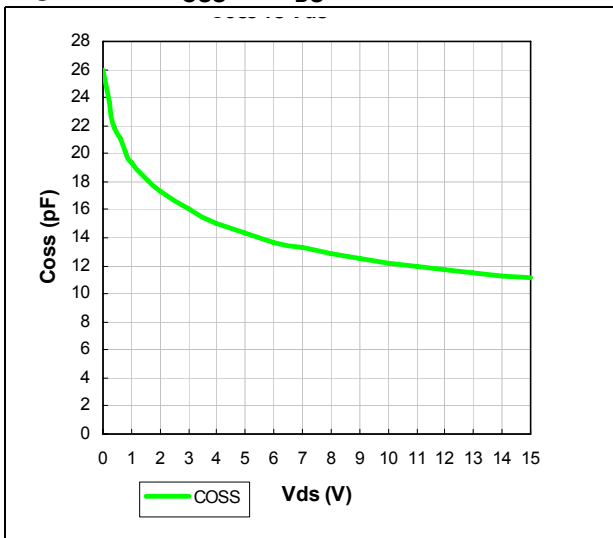

Figure 8. Gain vs output power and frequency

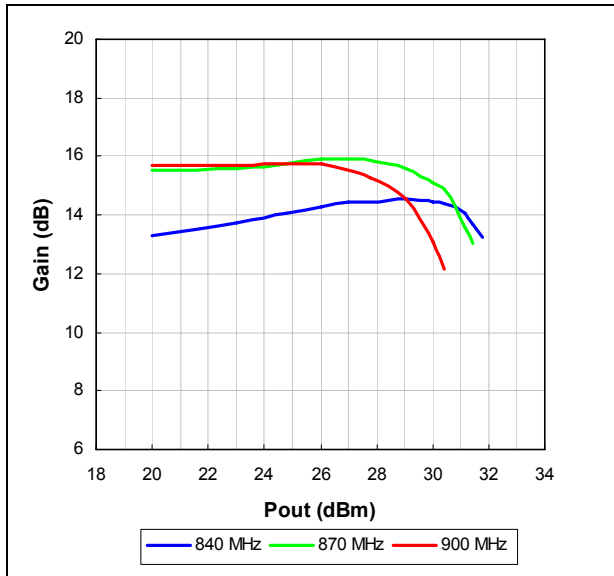

Figure 9. Output power vs input power and frequency

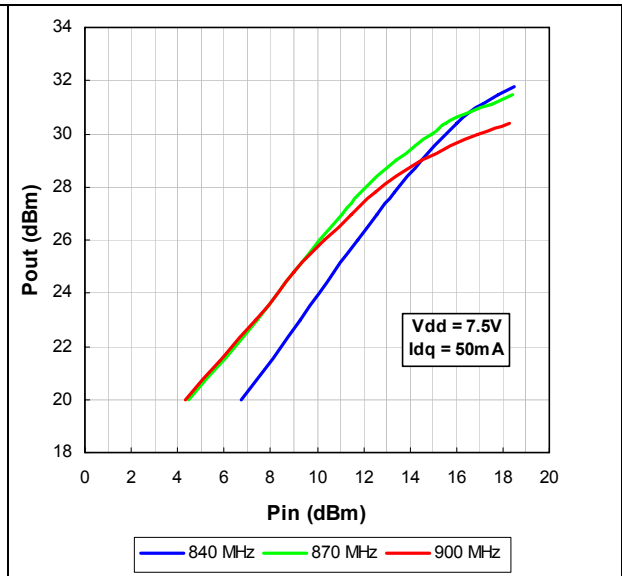

Figure 10. Efficiency vs output power and frequency

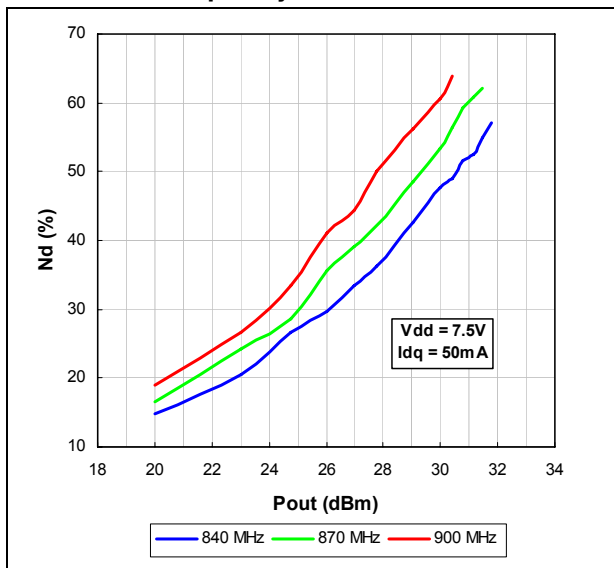

Figure 11. Gain and efficiency vs frequency

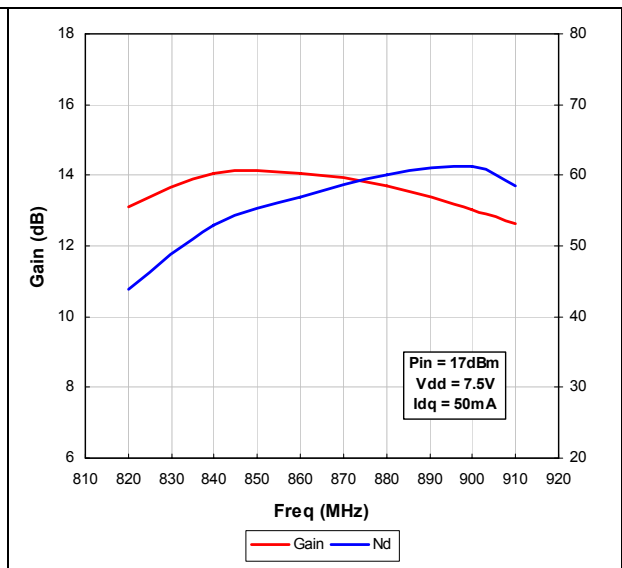

Figure 12. Input return loss vs frequency

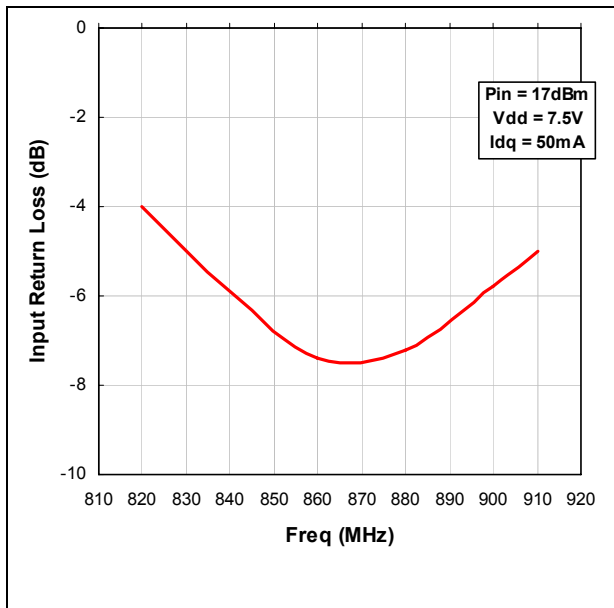

Figure 13. Output power vs input power and V_{DD}

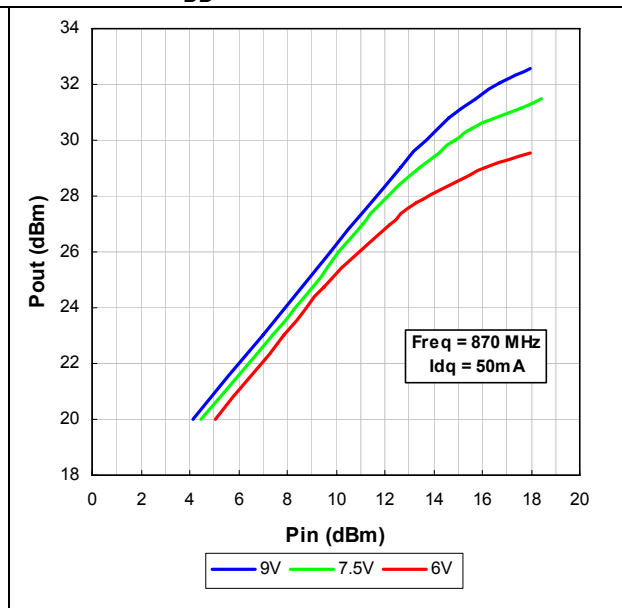

Figure 14. Efficiency vs output power and V_{DD}

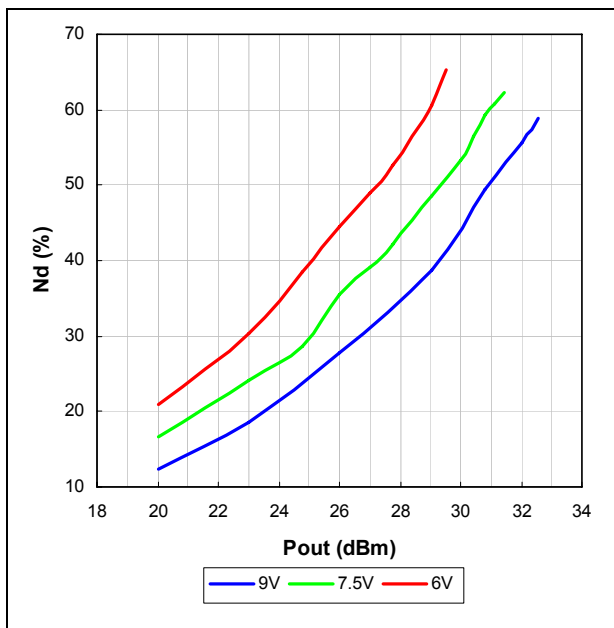

Figure 15. Output power and drain current vs drain supply voltage

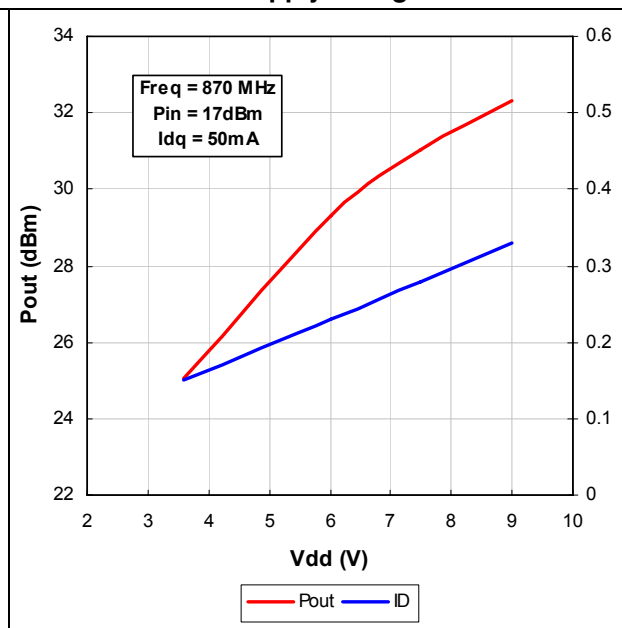
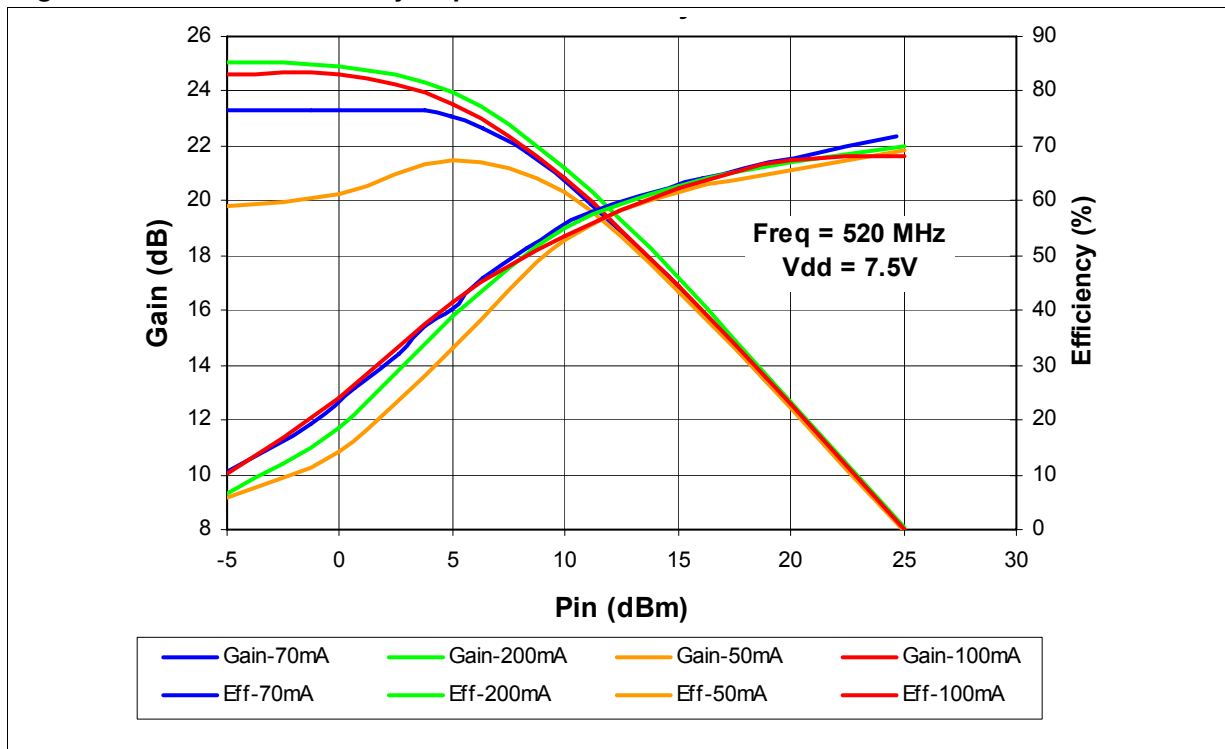
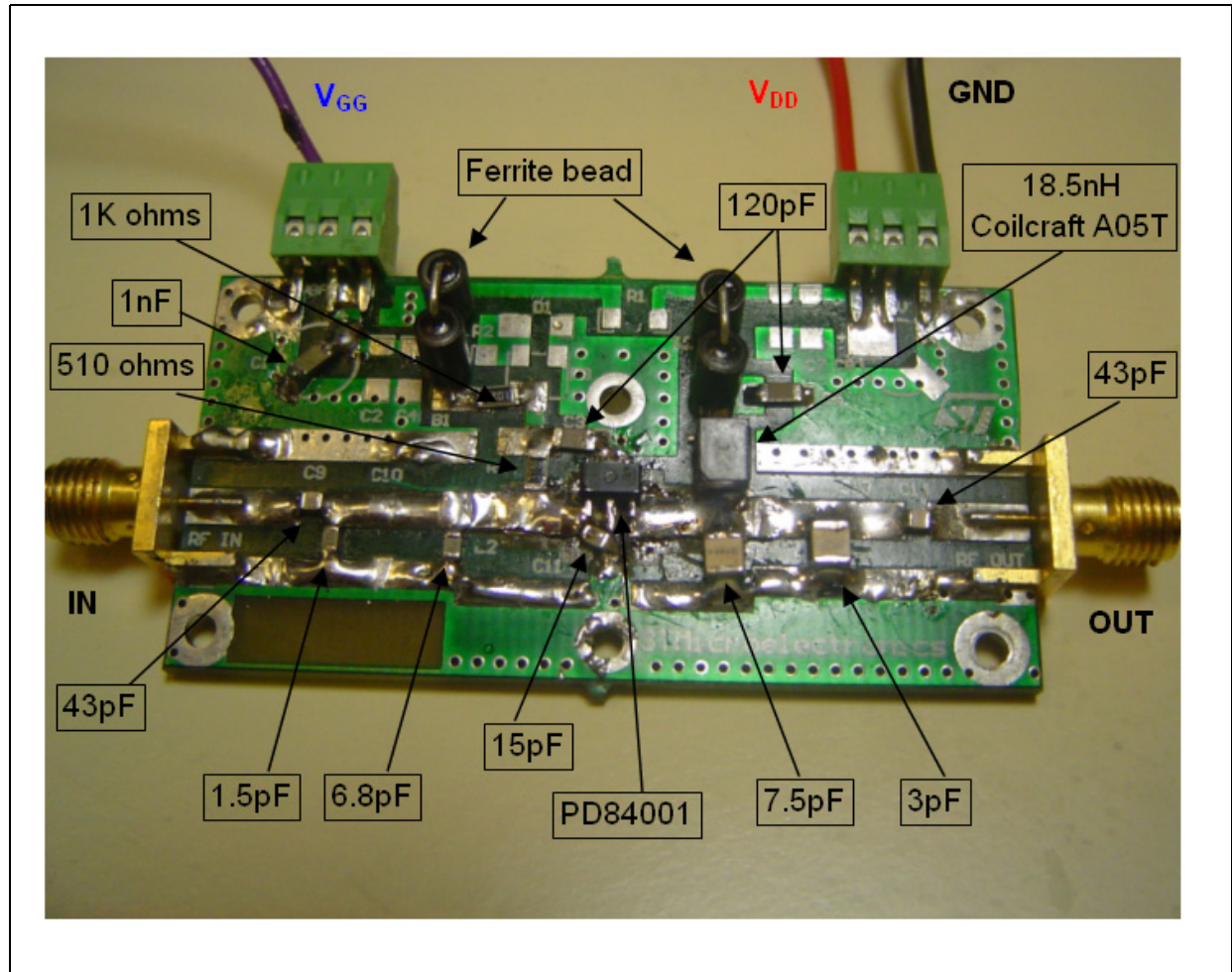

Figure 16. Gain and efficiency vs pin



5 Test circuit

Figure 17. Test circuit schematic / 840-900 MHz



6 Package mechanical data

In order to meet environmental requirements, ST offers these devices in ECOPACK® packages. These packages have a lead-free second level interconnect . The category of second level interconnect is marked on the package and on the inner box label, in compliance with JEDEC Standard JESD97. The maximum ratings related to soldering conditions are also marked on the inner box label. ECOPACK is an ST trademark. ECOPACK specifications are available at: www.st.com

Table 9. SOT-89 mechanical data

Dim.	mm.			Inch		
	Min	Typ	Max	Min	Typ	Max
A	1.4		1.6	55.1		63.0
B	0.44		0.56	17.3		22.0
B1	0.36		0.48	14.2		18.9
C	0.35		0.44	13.8		17.3
C1	0.35		0.44	13.8		17.3
D	4.4		4.6	173.2		181.1
D1	1.62		1.83	63.8		72.0
E	2.29		2.6	90.2		102.4
e	1.42		1.57	55.9		61.8
e1	2.92		3.07	115.0		120.9
H	3.94		4.25	155.1		167.3
L	0.89		1.2	35.0		47.2

Figure 18. Package dimensions

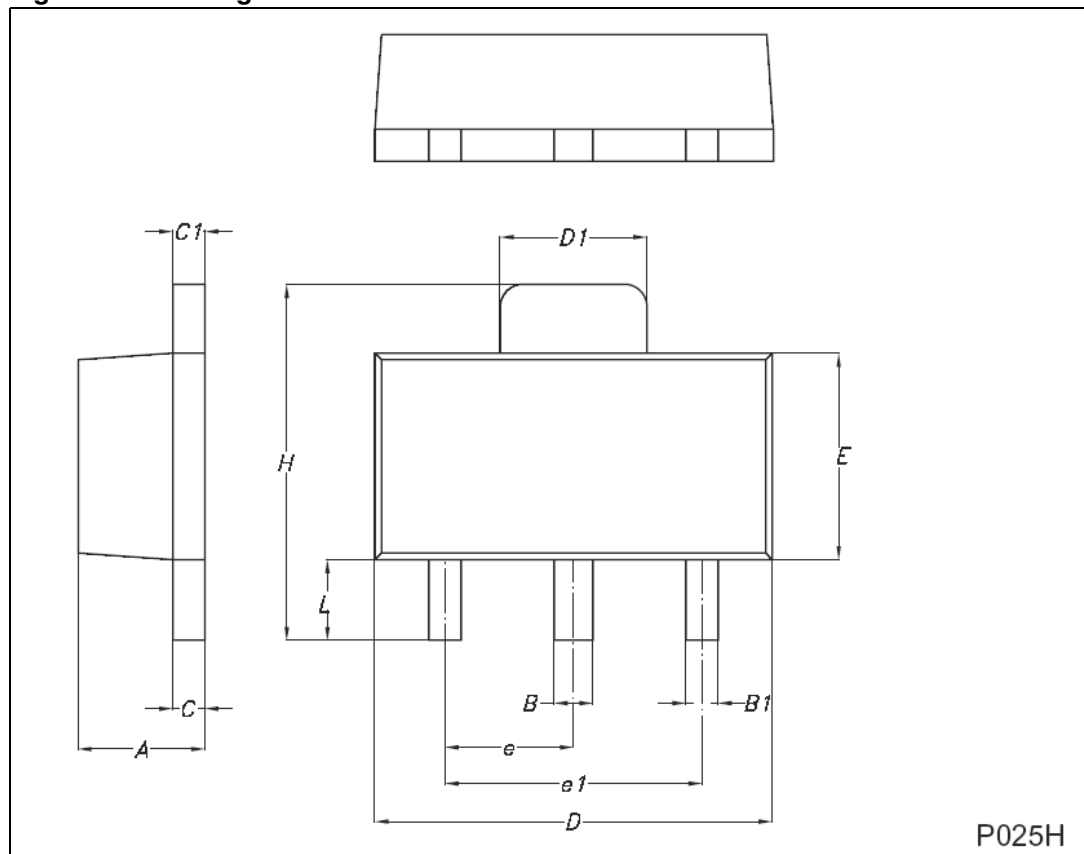

6.1 Thermal pad and via design

Thermal vias are required in the PCB layout to effectively conduct heat away from the package. The via pattern has been designed to address thermal, power dissipation and electrical requirements of the device.

The via pattern is based on thru-hole vias with 0.203 mm to 0.330 mm finished hole size on a 0.5 mm to 1.2 mm grid pattern with 0.025 plating on via walls. If micro vias are used in a design, it is suggested that the quantity of vias be increased by a 4:1 ratio to achieve similar results.

Figure 19. Pad layout details

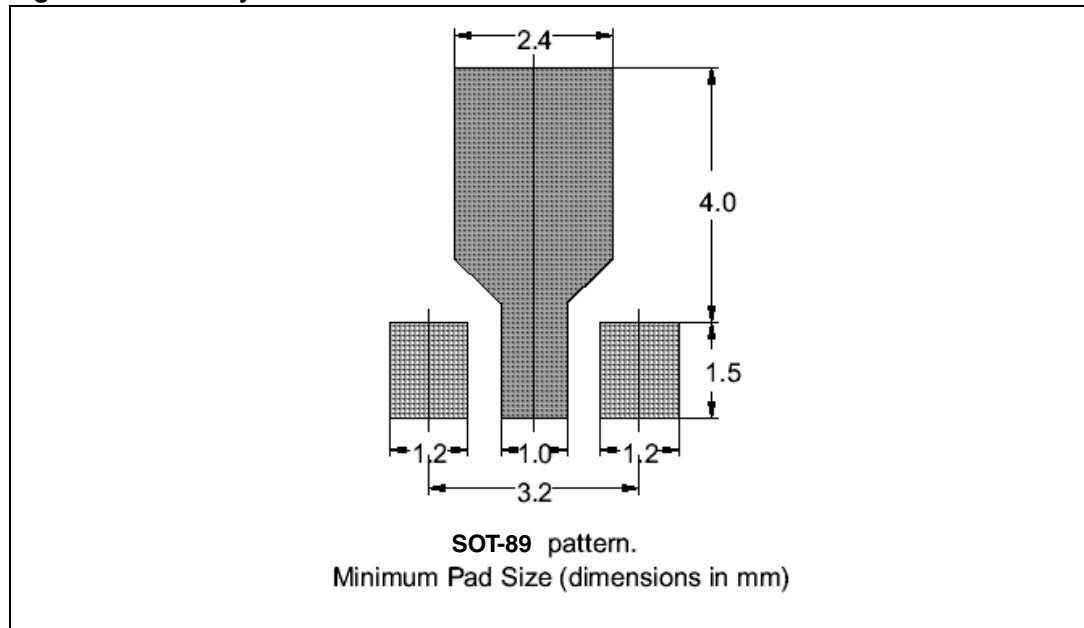

6.2 Soldering profile

Figure 20 shows the recommended solder for devices that have Pb-free terminal plating and where a Pb-free solder is used.

Figure 20. Recommended solder profile

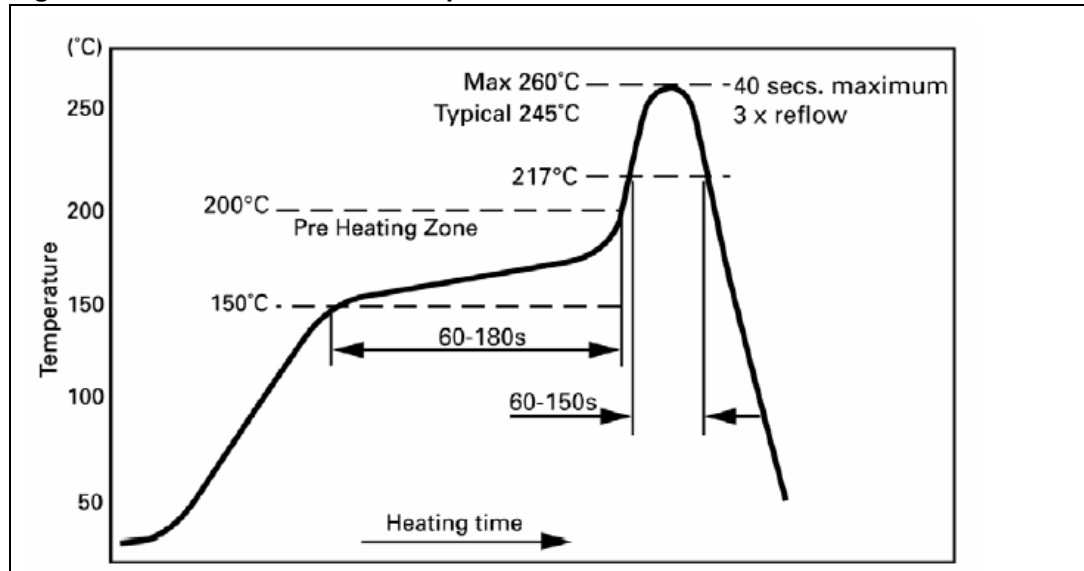

Figure 21 shows the recommended solder for devices with Pb-free terminal plating used with leaded solder, or for devices with leaded terminal plating used with a leaded solder.

Figure 21. Recommended solder profile for leaded devices

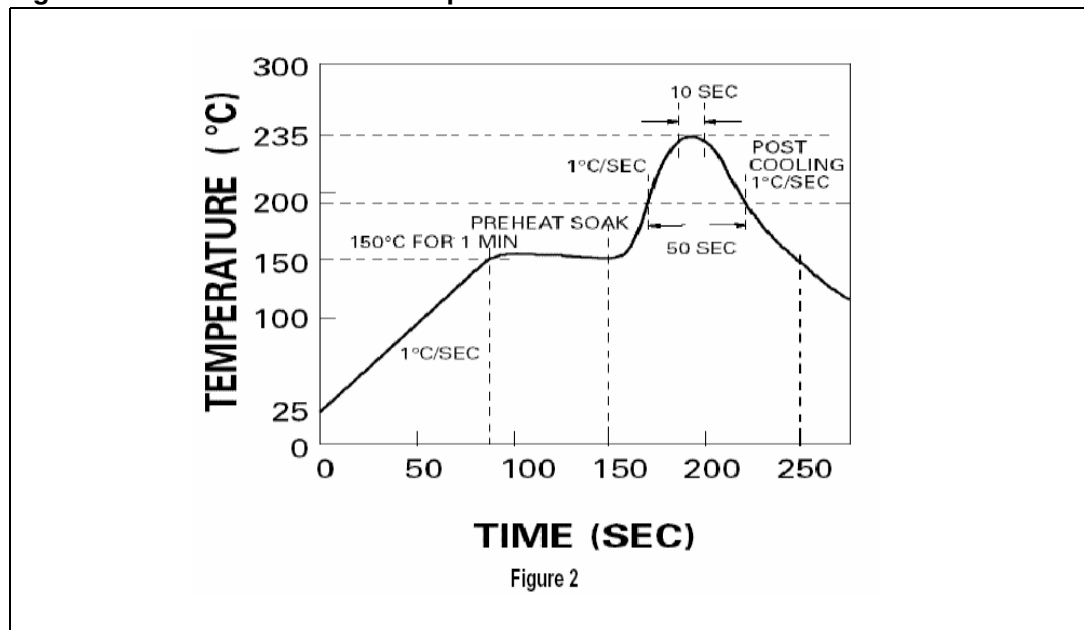
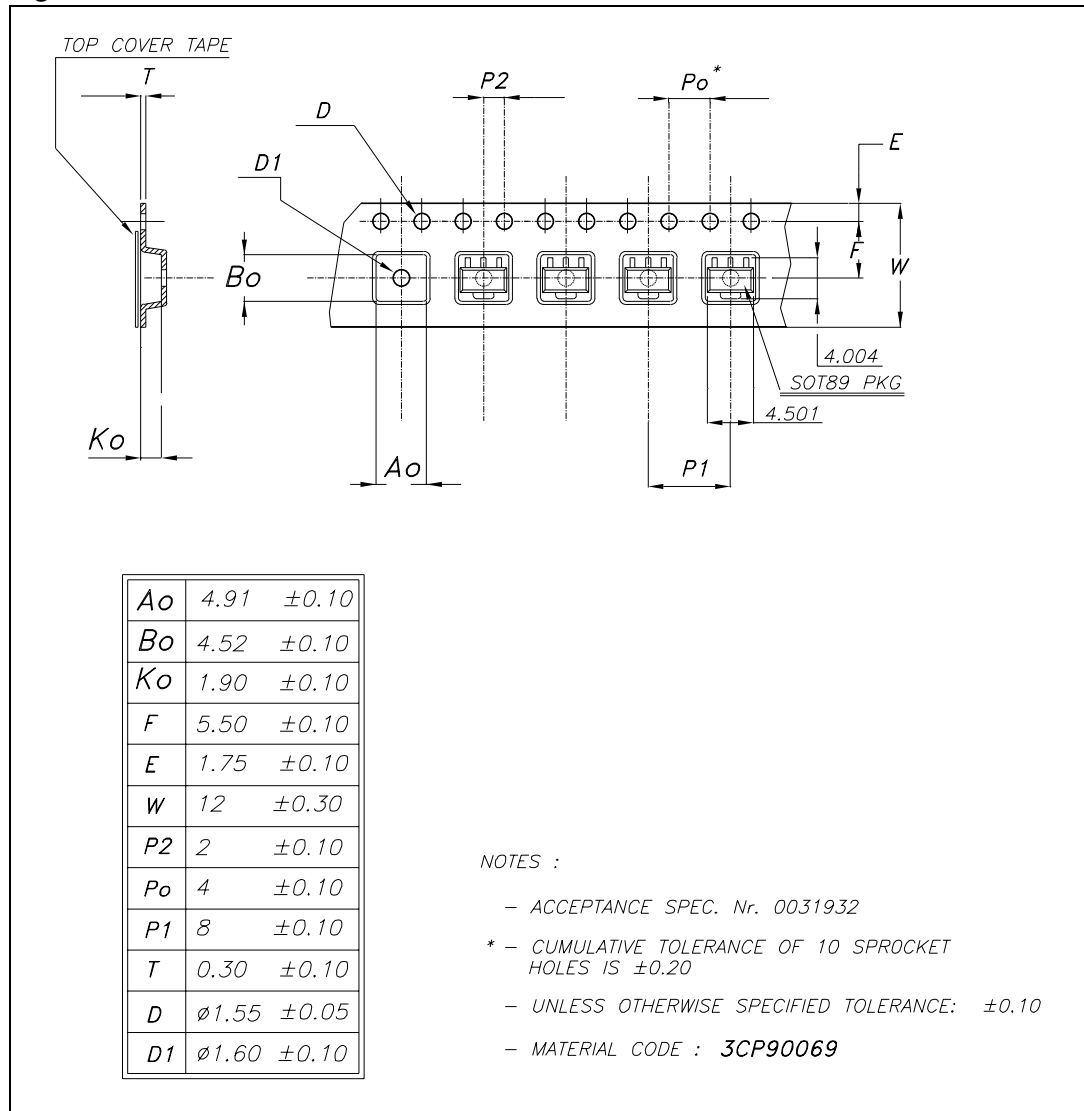

Figure 2

Figure 22. Reel information



7 Revision history

Table 10. Document revision history

Date	Revision	Changes
06-Dec-2006	1	Initial release
16-May-2007	2	Marking updated
05-Jun-2007	3	Part number update
25-Aug-2008	4	Updated Table 4 on page 4

Please Read Carefully:

Information in this document is provided solely in connection with ST products. STMicroelectronics NV and its subsidiaries ("ST") reserve the right to make changes, corrections, modifications or improvements, to this document, and the products and services described herein at any time, without notice.

All ST products are sold pursuant to ST's terms and conditions of sale.

Purchasers are solely responsible for the choice, selection and use of the ST products and services described herein, and ST assumes no liability whatsoever relating to the choice, selection or use of the ST products and services described herein.

No license, express or implied, by estoppel or otherwise, to any intellectual property rights is granted under this document. If any part of this document refers to any third party products or services it shall not be deemed a license grant by ST for the use of such third party products or services, or any intellectual property contained therein or considered as a warranty covering the use in any manner whatsoever of such third party products or services or any intellectual property contained therein.

UNLESS OTHERWISE SET FORTH IN ST'S TERMS AND CONDITIONS OF SALE ST DISCLAIMS ANY EXPRESS OR IMPLIED WARRANTY WITH RESPECT TO THE USE AND/OR SALE OF ST PRODUCTS INCLUDING WITHOUT LIMITATION IMPLIED WARRANTIES OF MERCHANTABILITY, FITNESS FOR A PARTICULAR PURPOSE (AND THEIR EQUIVALENTS UNDER THE LAWS OF ANY JURISDICTION), OR INFRINGEMENT OF ANY PATENT, COPYRIGHT OR OTHER INTELLECTUAL PROPERTY RIGHT.

UNLESS EXPRESSLY APPROVED IN WRITING BY AN AUTHORIZED ST REPRESENTATIVE, ST PRODUCTS ARE NOT RECOMMENDED, AUTHORIZED OR WARRANTED FOR USE IN MILITARY, AIR CRAFT, SPACE, LIFE SAVING, OR LIFE SUSTAINING APPLICATIONS, NOR IN PRODUCTS OR SYSTEMS WHERE FAILURE OR MALFUNCTION MAY RESULT IN PERSONAL INJURY, DEATH, OR SEVERE PROPERTY OR ENVIRONMENTAL DAMAGE. ST PRODUCTS WHICH ARE NOT SPECIFIED AS "AUTOMOTIVE GRADE" MAY ONLY BE USED IN AUTOMOTIVE APPLICATIONS AT USER'S OWN RISK.

Resale of ST products with provisions different from the statements and/or technical features set forth in this document shall immediately void any warranty granted by ST for the ST product or service described herein and shall not create or extend in any manner whatsoever, any liability of ST.

ST and the ST logo are trademarks or registered trademarks of ST in various countries.

Information in this document supersedes and replaces all information previously supplied.

The ST logo is a registered trademark of STMicroelectronics. All other names are the property of their respective owners.

© 2008 STMicroelectronics - All rights reserved

STMicroelectronics group of companies

Australia - Belgium - Brazil - Canada - China - Czech Republic - Finland - France - Germany - Hong Kong - India - Israel - Italy - Japan - Malaysia - Malta - Morocco - Singapore - Spain - Sweden - Switzerland - United Kingdom - United States of America

www.st.com